

## 1.1 Leveromvang

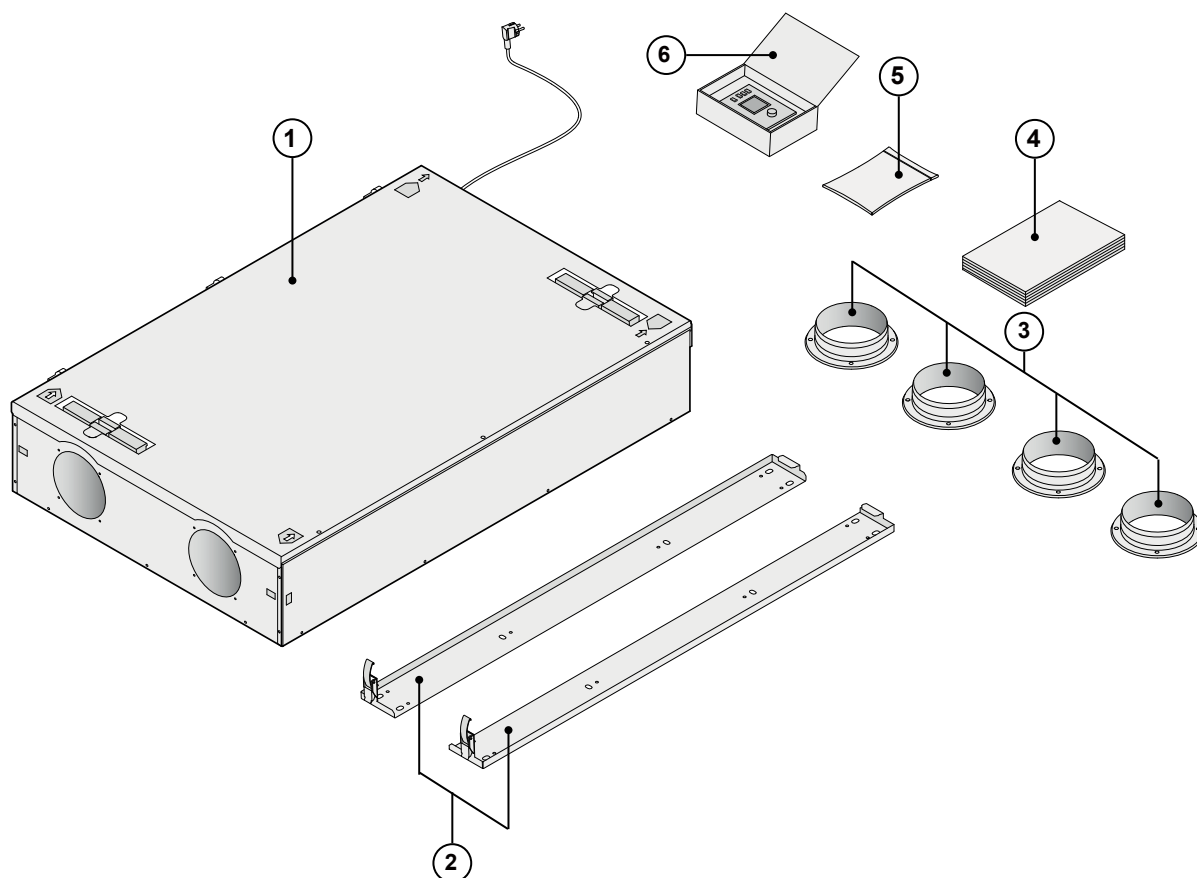



Controleer voordat men begint met de installatie van het warmteterugwintoestel of deze compleet en onbeschadigd is geleverd. De leveromvang van het warmteterugwintoestel type Renovent Sky 150 omvat de volgende componenten:

- 1: Warmteterugwintoestel
- 2: Ophangbeugelset;
  - 2x ophangstrips
- 3: Kanaalaansluitset;
  - 4x boordringen Ø125 mm
- 4: Documentatieset;
  - 1x installatievoorschrift
- 5: Aansluitset;
  - Montagemateriaal boordringen bestaande uit 16 bevestigingsschroeven
  - Connectoren : 2-polige schroefconnector (eBus) en 9-polige schroefconnector (alleen bij Plus uitvoering)
  - Condensafvoeraansluiting 3/4" x 32 mm
- 6: Brink Air Control inclusief bedieningshandleiding

## 1.2 Accessoires Renovent Sky 150

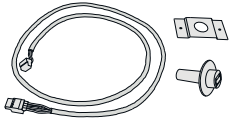
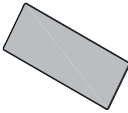
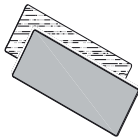
Elektrische naverwarmer		310730
Elektrische (extra) voorverwarmer		310740
Splitter RJ12		510472
CO <sub>2</sub> -sensor eBus opbouw uitvoering		532126
Zender draadloze afstandbediening 2 standen (incl. batterij)		532170
Zender draadloze afstandbediening 4 standen (incl. batterij)		532171
Ontvanger draadloze afstandbediening (t.b.v. batterij uitvoering)		532172
Set draadloze afstandbediening 2 standen (1 zender & 1 ontvanger)		532173
Set draadloze afstandbediening 4 standen (1 zender & 1 ontvanger)		532174

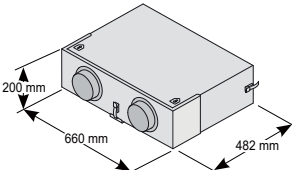
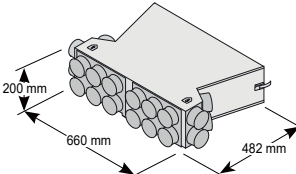
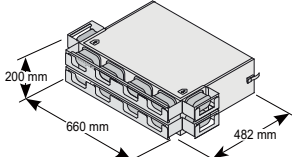
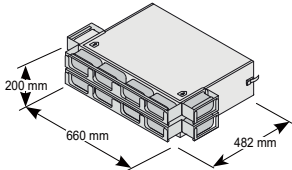
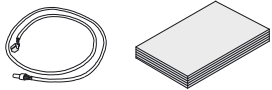
<p>RH (vochtigheid)-sensor</p>		<p>310657</p>
<p>Filterset 1 x ISO ePM 1 50% (F7) filter (1 stuks)</p>		<p>533001</p>
<p>Filterset 1x ISO Coarse 60% (F7) &amp; 1x ISO ePM 1 50% (F7) (2 stuks)</p>		<p>533002</p>
<p>4-Standenschakelaar wit met filterindicatie; inbouw; modulaire aansluiting.</p>		<p>540262</p>
<p>Geluidemperkast Ø125 mm (2x)</p>		<p>423010</p>
<p>Geluidemper-/ luchtverdeelkast Ø75 mm (20x)</p>		<p>423011</p>
<p>Demper -/ luchtverdeelkast 100 x 50 mm (12x)</p>		<p>423012</p>
<p>Demper-/ luchtverdeelkast 130 x 60 mm (12x)</p>		<p>423013</p>
<p>Servicetool</p>		<p>531961</p>